

Customer Experience Center  
1-800-331-4331

 **TOYOTA** *Owners*  
ToyotaOwnersOnline.com

 **TOYOTA**

*moving forward ▶*

*CAMRY*  
**SOLARA**



**2007**  
*Pocket Reference Guide*

MN 00452-PRG07-SOL  
Printed in USA 5/06

# 2007 Camry Solara

This *Pocket Reference Guide* is a summary of basic vehicle operations. It contains brief descriptions of fundamental operations so you can locate and use the vehicle's main equipment quickly and easily.

The *Pocket Reference Guide* is not intended as a substitute for the *Owner's Manual* located in your vehicle's glove box. We strongly encourage you to review the *Owner's Manual* and supplementary manuals so you will have a better understanding of your vehicle's capabilities and limitations.

Your dealership and the entire staff of Toyota Motor Sales, U.S.A., Inc. wish you many years of satisfied driving in your new Camry Solara.

## **! A word about safe vehicle operations**

This *Pocket Reference Guide* is not a full description of Camry Solara operations. Every Camry Solara owner should review the *Owner's Manual* that accompanies this vehicle.

Pay special attention to the boxed information highlighted in yellow throughout the *Owner's Manual*. Each box contains safe operating instructions to help you avoid injury or equipment malfunction.

All information in this *Pocket Reference Guide* is current at the time of printing. Toyota reserves the right to make changes at any time without notice.

# INDEX

Item	Page no.
<b>OVERVIEW</b>	
Engine maintenance	8
Fuel tank door release and cap	6
Hood release	7
Indicator symbols	4-5
Instrument cluster	4
Instrument panel	2-3
<b>Keyless entry<sup>1</sup></b>	<b>6</b>
Light control-Instrument panel	7
Trunk release lever	7
<b>FEATURES/OPERATIONS</b>	
Air Conditioning/Heating	18
Audio	16-17
<b>Auto lock functions<sup>1</sup></b>	<b>9</b>
Automatic transmission	9
Clock	15
Convertible top operation	15
Cruise control	14
Cup holders	15
Door locks	11
Garage door opener (HomeLink <sup>®</sup> ) <sup>3</sup>	17
<b>Lights<sup>2</sup> &amp; turn signals</b>	<b>12-13</b>
Multi-information display	11
Moonroof	13
Parking brake	9
Power outlets	19
Seat adjustments-Front	10
Seat adjustments-Rear	10
Seats-Head restraints	10
Telephone controls (Bluetooth <sup>®</sup> )	14
Telescopic and tilt steering wheel	11
Windows	19
Windshield wiper & washer	13
<b>SAFETY AND EMERGENCY FEATURES</b>	
Seat belts	20
Seat belt hangers	20
Spare tire & tools	21
Tire Pressure Warning System reset	20
Trunk-Internal release	21

<sup>1</sup> Programmable by customer. Refer to the Owner's Manual for instructions and more information.

<sup>2</sup> Visit your Toyota dealer for information on customizing this feature.

<sup>3</sup> HomeLink<sup>®</sup> is a registered trademark of Johnson Controls, Inc.

# OVERVIEW

## Instrument panel

### Steering wheel controls

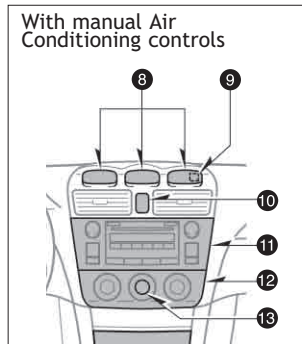
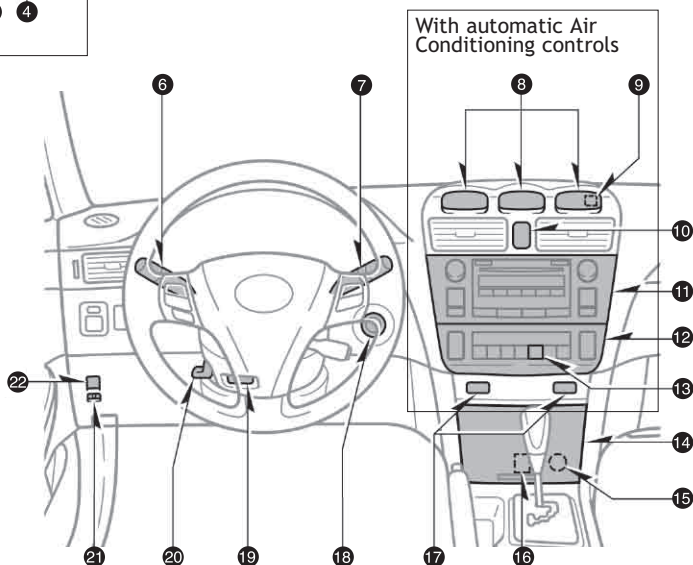
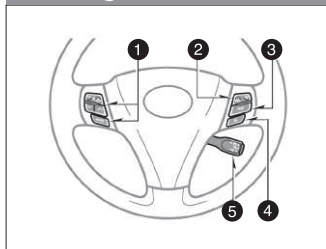

- ❶ Steering wheel audio control
- ❷ Telephone controls<sup>1</sup>
- ❸ Multi-information display switch
- ❹ Speech command button<sup>1,2</sup>
- ❺ Cruise control
- ❻ Headlight, turn signal and front fog light controls
- ❼ Wiper and washer controls
- ❽ Multi-information displays
- ❾ Front passenger occupant classification indicator light/front passenger seat belt reminder light
- ❿ Emergency flasher switch
- ⓫ Audio system or navigation system with integrated audio system<sup>1,2</sup>
- ⓬ Air Conditioning controls

- Ⓜ Rear window and outside rear view mirror defogger switch<sup>1</sup>
- Ⓨ Auxiliary boxes
- Ⓩ 12V DC Power outlet
- ⓐ AUX adapter
- ⓑ Seat heater switches<sup>1</sup>
- ⓓ Ignition switch
- ⓔ Tilt steering lock release
- ⓕ Telescopic steering lock release
- ⓖ Tire Pressure Warning System reset switch
- ⓗ "TRAC OFF" (Traction Control "OFF")

<sup>1</sup> If equipped

<sup>2</sup> For details, refer to the "Navigation System Owner's Manual."

## OVERVIEW

## Instrument cluster

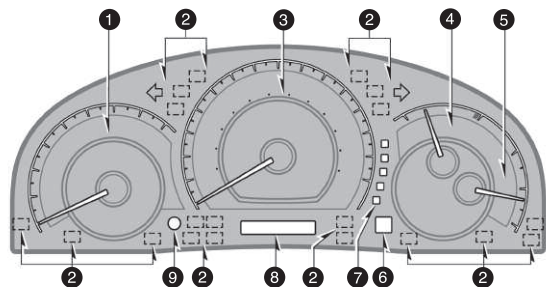

- 1 Tachometer
- 2 Service indicator and reminder
- 3 Speedometer
- 4 Engine coolant temperature
- 5 Fuel gauge
- 6 Sequential shift display\*
- 7 Gear shift position indicator\*
- 8 Odometer and two trip meters
- 9 Trip meter reset/Instrument panel light control

\* If equipped

## Indicator symbols

<b>BRAKE</b>	Brake system warning <sup>1</sup>
	Driver seat belt reminder <sup>1</sup> (Alarm will sound if speed is over 12 mph.)
<b>PASSENGER</b> 	Front passenger seat belt reminder <sup>1</sup> (Alarm will sound if speed is over 12 mph.)
	Charging system warning <sup>1</sup>
<b>CHECK</b> 	Malfunction/Check Engine indicator <sup>1</sup>
	Low engine oil pressure warning <sup>1</sup>
	Open door warning <sup>1</sup>
	Airbag SRS warning <sup>1</sup>

<sup>1</sup> For details, refer to "Service reminder indicators and warning buzzers," Section 1-6, 2007 Owner's Manual.

	Low windshield washer fluid level warning <sup>1</sup>
<b>VSC</b>	Vehicle Stability Control/Traction Control warning <sup>1</sup>
	Low tire pressure warning <sup>1</sup>
<b>MAINT</b>	Engine oil replacement reminder <sup>1</sup>
<b>PASSENGER AIRBAG OFF ON</b>	Front passenger occupant classification indicator
	Headlight indicator
	Headlight high beam indicator
	Turn signal indicator
	Low fuel level warning <sup>1</sup>
	Slip indicator
<b>CRUISE</b>	Cruise control indicator <sup>2</sup>
<b>TRAC OFF</b>	Traction Control "OFF" indicator
	Engine immobilizer/Theft deterrent system indicator light
<b>ABS</b>	Anti-lock Brake System warning <sup>1</sup>

**CAUTION**

When the anti-lock brake system (ABS) function is in action, you may feel the brake pedal pulsating and hear a noise. In this situation, to let the anti-lock brake system work for you, just hold the brake pedal down more firmly. Do not pump the brake as this will result in reduced braking performance.

<sup>2</sup> If this light flashes, refer to "Cruise control," Section 1-7, 2007 Owner's Manual.

## OVERVIEW

## Fuel tank door release and cap

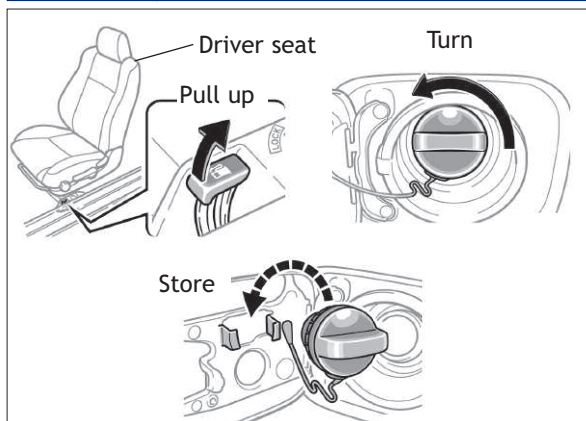

**NOTE:** Tighten until one click is heard. If the cap is not tightened enough, Check Engine “” indicator may illuminate.

## Keyless entry

Beep sound can be switched “ON” or “OFF.” Refer to the *Owner’s Manual* for more details.

## Locking operation



## Unlocking operation

Push ONCE: Driver door  
TWICE: All doors



**NOTE:** After unlocking, if a door is not opened within 60 seconds, all doors will relock for safety.

## Trunk lid operation

Push and hold



## Alarm operation

Push and hold



6

## Light control-Instrument panel

Brightness control

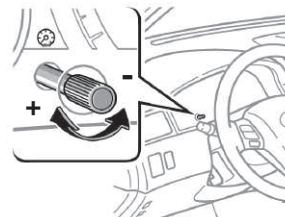

With the knob turned fully clockwise, instrument panel lights will not dim when the headlights are turned on.

**Note:** This is also the trip meter reset button. Refer to the *Owner’s Manual* for more details.

## Trunk release lever

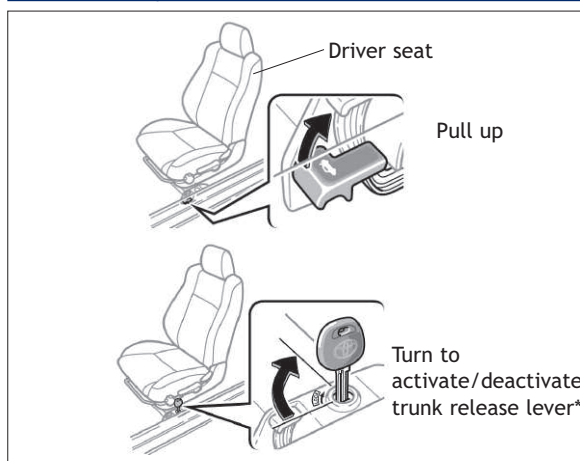

\*Master/Black key only

## Hood release

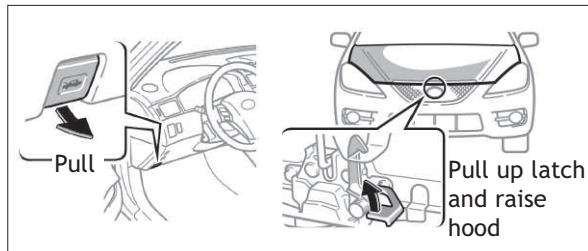

7

## OVERVIEW

## Engine maintenance

## 4 cylinder (2AZ-FE) engine

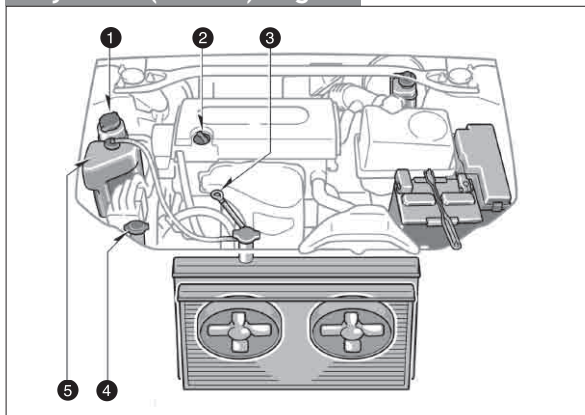

## 6 cylinder (3MZ-FE) engine

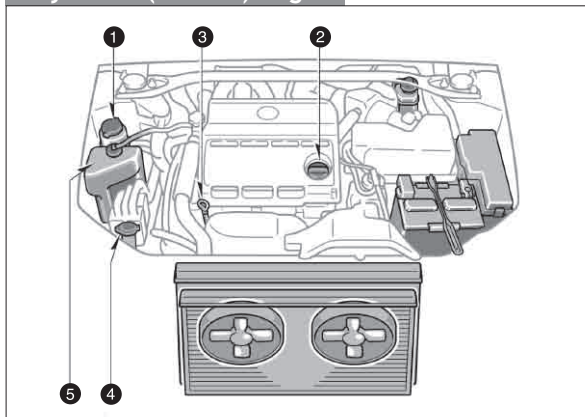

- 1 Power steering fluid reservoir
- 2 Engine oil filler cap
- 3 Engine oil level dipstick
- 4 Windshield washer fluid tank
- 5 Engine coolant reservoir

**Note:** Regularly scheduled maintenance, including oil changes, will help extend the life of your vehicle and maintain performance. Please refer to the "Owner's Warranty Information Booklet," "Scheduled Maintenance Guide" or "Owner's Manual Supplement."

## FEATURES/OPERATIONS

## Auto lock functions

Automatic door locks can be programmed to operate in 3 different modes, or turned OFF.

- Doors lock when shifting from Park.\*
- Doors unlock when shifting into Park.\*
- Doors unlock when the ignition switch is turned from ON to ACC or LOCK and driver's door is opened.

\* Automatic transmission only

Refer to the *Owner's Manual* for more details.

## Automatic Transmission (if equipped)

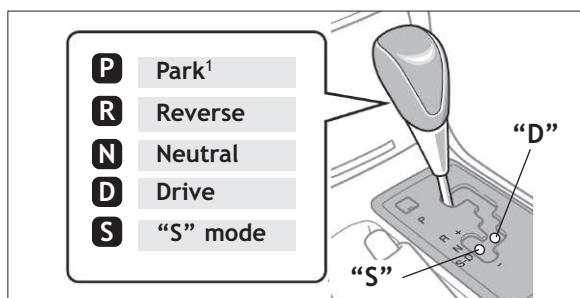

<sup>1</sup> The ignition switch must be ON, and the brake pedal depressed to shift from "Park."

## "S" (Sequential) mode

Push shift lever to the left from "D" position.

## "S" position:

- +: Upshift (Push and release)
- : Downshift (Pull and release)

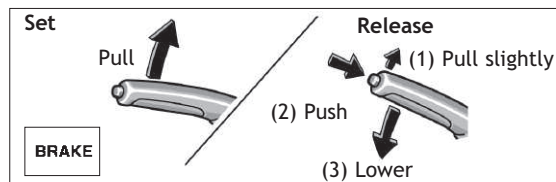

Downshifting increases power going uphill, or provides engine braking downhill. For best fuel economy during normal driving conditions, always drive with the shift lever in the "D" position.

## Parking brake

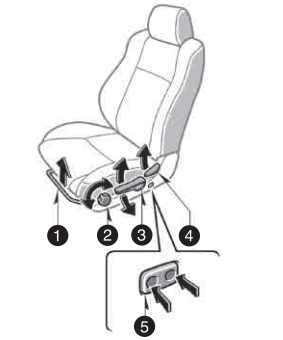

## FEATURES/OPERATIONS

### Seat adjustments-Front

Manual Seat	Power Seat
	

- ① Position
- ② Cushion angle
- ③ Height crank (driver side only)
- ④ Seatback angle and lock release
- ⑤ Lumbar support (driver side only)
- ⑥ Position and height
- ⑦ Seatback lock release

**NOTE:** Ensure seat is locked back into place.

### Seat adjustments-Rear (hardtop only)

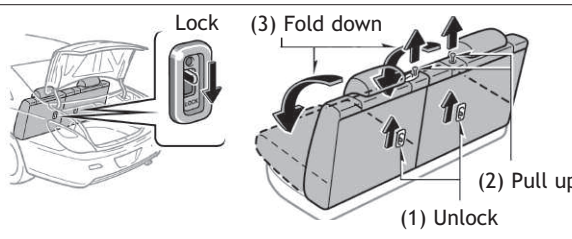

### Seats-Head restraints

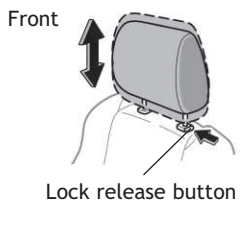
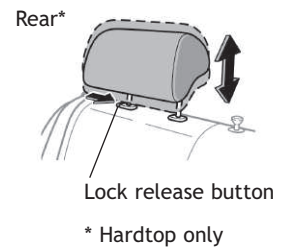
	
Front	Rear*
Lock release button	Lock release button
	* Hardtop only

### Telescopic and tilt steering wheel

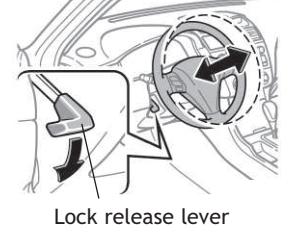
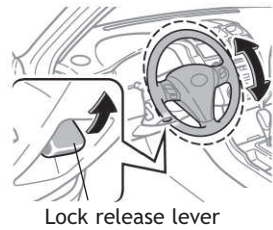
Length	Angle
	
Lock release lever	Lock release lever

**Note:** Do not attempt to adjust while the vehicle is in motion.

### Multi-information display

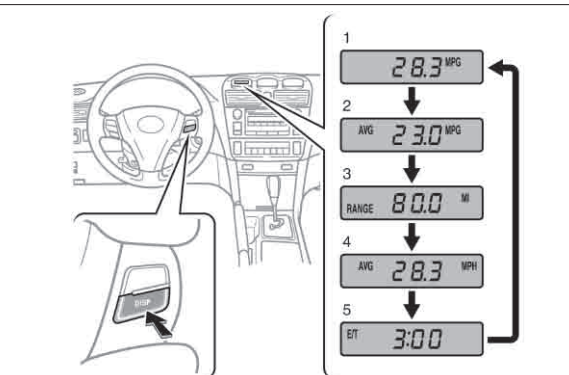

Push "DISP" to change information in the following succession.

- (1) Current gas mileage (MPG)
- (2) Average gas mileage (AVG/MPG)
- (3) Miles left on remaining fuel (RANGE/MI)
- (4) Average vehicle speed from engine start (AVG/MPH)
- (5) Running time from engine start (E/T)

### Door locks

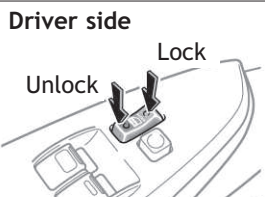
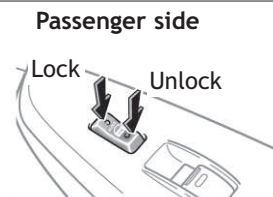
Driver side	Passenger side
	
Lock	Lock
Unlock	Unlock



## FEATURES/OPERATIONS

### Lights & turn signals

#### Headlights

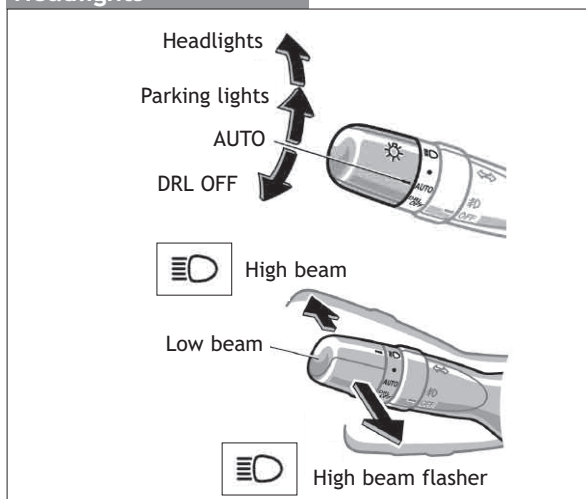

-**Daytime Running Light system (DRL)** Automatically turns on the headlights at a reduced intensity.

-**Automatic light cut off system** Will automatically turn lights off after a delay of thirty (30) seconds, or the lock switch on remote may be pushed.

#### Turn signals

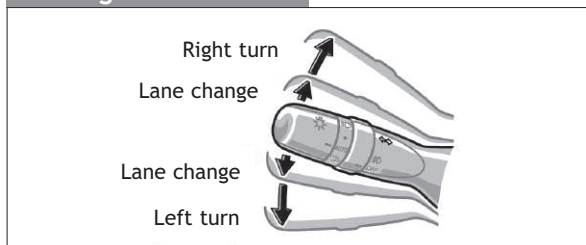

#### Front fog lights

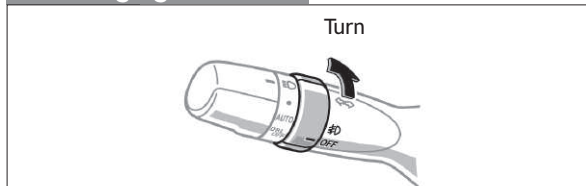

Front fog lights come on only when the headlights are on low beam.

### Headlight beam level control (if equipped)

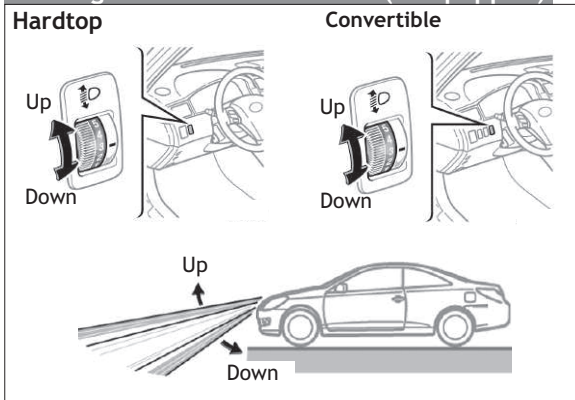

Higher number will lower the beam.

### Windshield wiper & washer

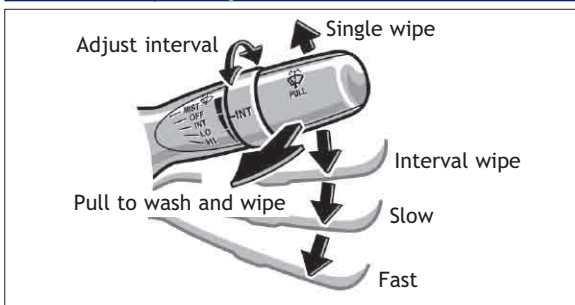

### Moonroof (if equipped)

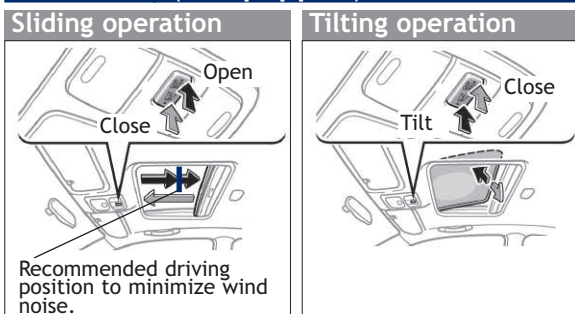

**NOTE:** If battery is disconnected, the moonroof needs to be reinitialized. Refer to the *Owner's Manual* for more details.

## FEATURES/OPERATIONS

### Cruise control

#### Turning system ON/OFF

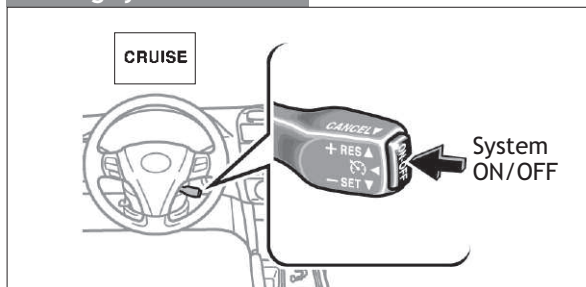

#### Functions

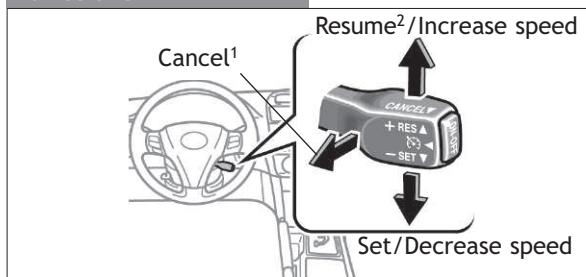

<sup>1</sup> The set speed may also be cancelled by depressing the brake pedal.

<sup>2</sup> The set speed may be resumed once vehicle speed exceeds 25 mph.

Refer to the *Owner's Manual* for more details.

### Telephone controls (Bluetooth®)\* (if equipped)

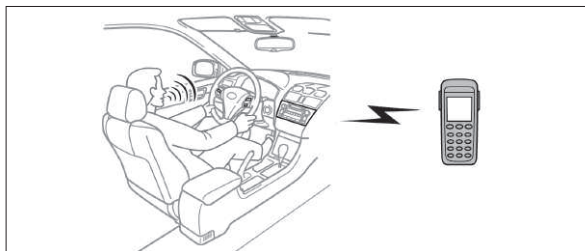

Bluetooth® technology allows dialing or receipt of calls without taking your hands from the steering wheel or using a cable to connect the telephone and the system.

Refer to the *Owner's Manual* for more details.

### Convertible top operation (if equipped)

#### Lowering the convertible top

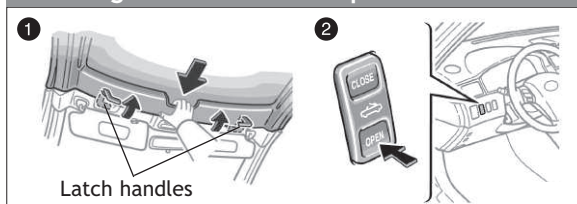

- 1 Lower the sun visors, then hold the top down while releasing both latches.
- 2 Push and hold the switch on the "OPEN" side until the convertible top is completely lowered.

#### Raising the convertible top

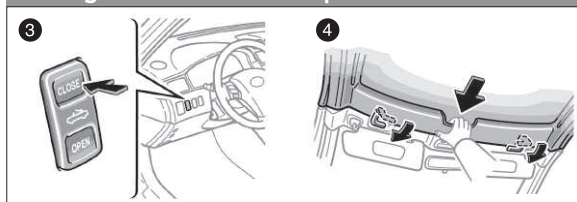

- 3 Lower the sun visors. Push the switch on the "CLOSE" side until the top stops moving.
- 4 Pull down the convertible top and push the latch handles fully forward until they are hooked.

Refer to the *Owner's Manual* for more details.

### Clock

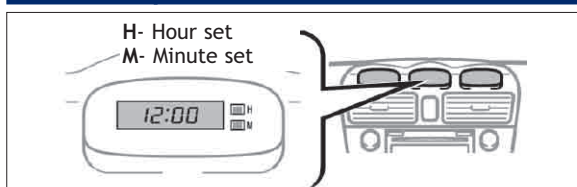

### Cup holders

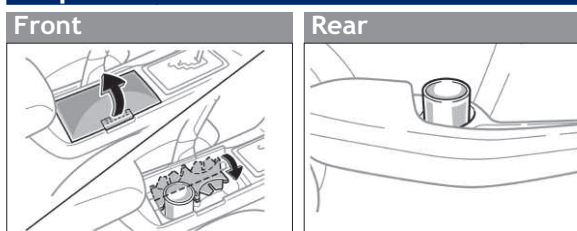

## FEATURES/OPERATIONS

### Audio

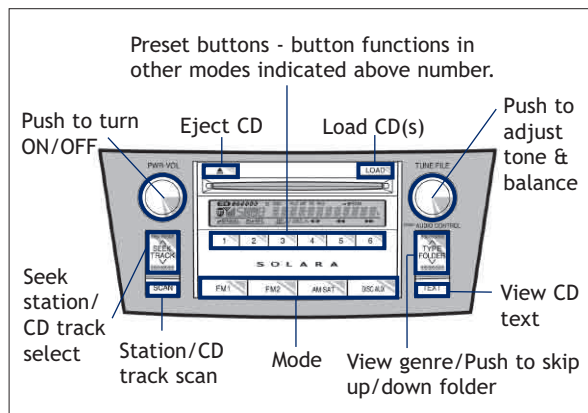

### CD PLAYER

To scan tracks on a disc Push and hold "SCAN." Push again to hold selection.

### CD Changer

-To load one disc Push "LOAD" and insert 1 disc.  
 -To load multiple discs Push and hold "LOAD" until you hear a beep. Insert one disc. **Wait until the green indicator illuminates and shutter opens to insert next disc.**

### RADIO

To preset stations Tune in the desired station and hold down a preset button (1-6) until you hear a beep. Push desired preset button (1-6) to select.  
 To scan stations Push "SCAN." Push and hold to scan preset stations. Push again to hold selection.

### AUX audio jack



By inserting a mini plug into the AUX audio jack, you can listen to music from a portable audio device through the vehicle's speaker system.

### Steering wheel controls

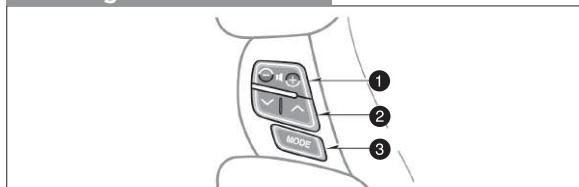

- ① "- +"  
Volume control
- ② " ^ v "  
-In radio mode Push to select a preset station; push and hold to seek the next strong station.  
-In CD mode Push to skip up or down to next/previous track.
- ③ "MODE"  
Push to turn audio ON and select an audio mode. Push and hold to turn the audio system OFF.

### Garage door opener (HomeLink®)\* (if equipped)

#### Hardtop

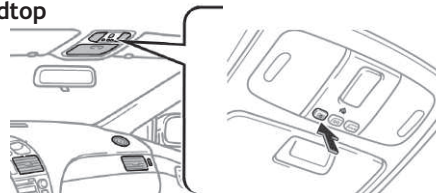

#### Convertible

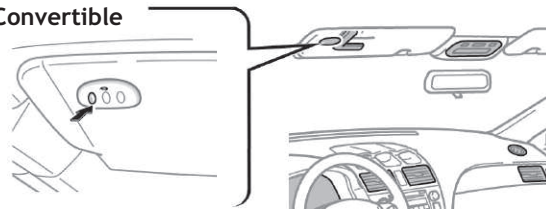

Garage door openers manufactured under license from HomeLink®\* can be programmed to operate garage doors, estate gates, security lighting, etc.

Refer to the *Owner's Manual* for more details. For programming assistance, contact the Toyota Customer Experience Center at 1-800-331-4331, or visit <http://www.homelink.com>

\*HomeLink® is a registered trademark of Johnson Controls, Inc.

## FEATURES/OPERATIONS

### Air Conditioning/Heating

#### Automatic Air Conditioning

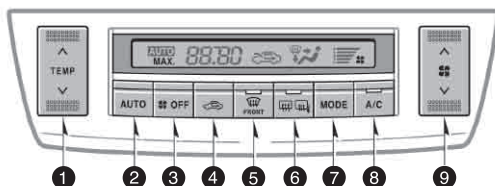

- 1 Temperature
- 2 Automatic climate control ON
- 3 Climate control OFF
- 4 Fresh or recirculate cabin air
- 5 Windshield defogger
- 6 Rear window and outside rear view mirror defogger
- 7 Air flow vent "MODE"  
In "☀️" or "☁️" mode, use fresh air ("🚗" indicator) to reduce window fogging.
- 8 Air Conditioning ON/OFF
- 9 Fan speed

#### Manual Air Conditioning

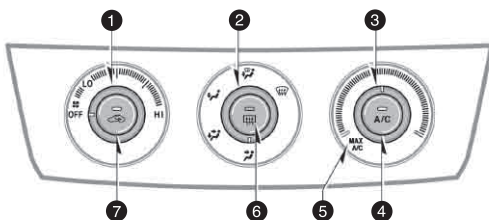

- 1 Fan speed
- 2 Air flow vent  
In "☀️" or "☁️" mode, use fresh air ("🚗" indicator light "OFF") to reduce window fogging.
- 3 Temperature
- 4 Air Conditioning ON/OFF
- 5 Use for quick cooling. MAX A/C changes air intake to recirculate. It is not possible to change intake to fresh, or to turn A/C OFF in this mode.
- 6 Rear window and outside rear view mirror defogger
- 7 Fresh or recirculate cabin air

### Windows

#### Driver side

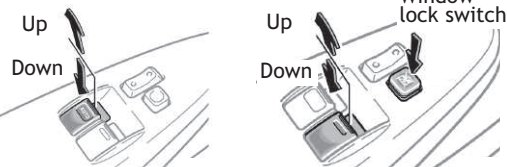

#### Window operation

**Automatic operation (Driver side only)** Push the switch completely down or pull it completely up and release to fully open or close\*. To stop window mid-way, lightly push the switch in the opposite direction.

\* Auto close on hardtop only

**Window lock switch** Deactivates all passenger windows. Driver's window remains operable.

**NOTE:** If battery is disconnected, the window needs to be reinitialized. Refer to the *Owner's Manual* for more details.

#### All windows (convertible only)

##### Side and quarter windows

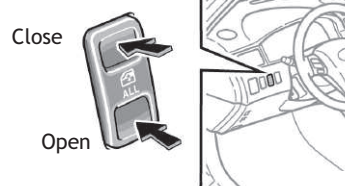

### Power outlets

#### Auxiliary box (12V)

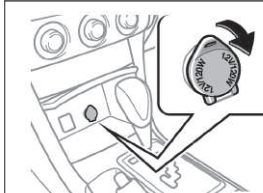

#### Console box (12V)

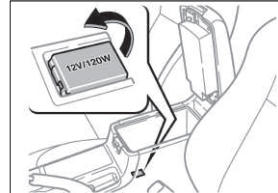

Designed for car accessories. Key must be in the "ACC" or "ON" position to be used.

## SAFETY AND EMERGENCY FEATURES

### Seat belts

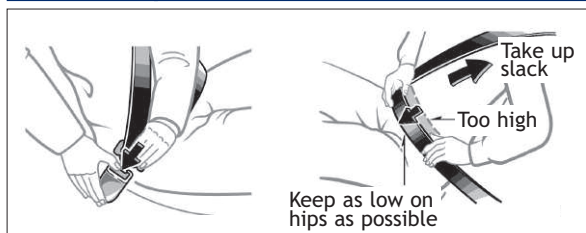

If belt is fully extended, then retracted even slightly, it cannot be re-extended beyond that point, unless fully retracted again. This feature is used to help hold child restraint systems securely.

To find more information about seat belts, and how to install a child restraint system, refer to the *Owner's Manual*.

### Seat belt hangers

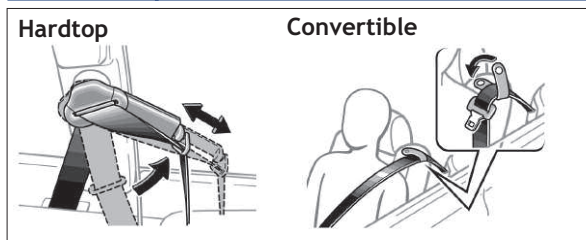

### Tire Pressure Warning System reset

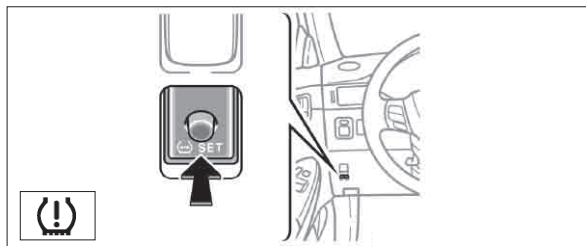

If tire pressure becomes low on any of the tires (including spare/excluding compact spare), indicator comes on. Pushing reset button should not turn off the light. Correctly adjusting tire inflation will turn off the light after a few minutes. Push and hold reset button until the indicator light blinks 3 times, after replacing tire or wheels.

## Spare tire & tools

### Tool location

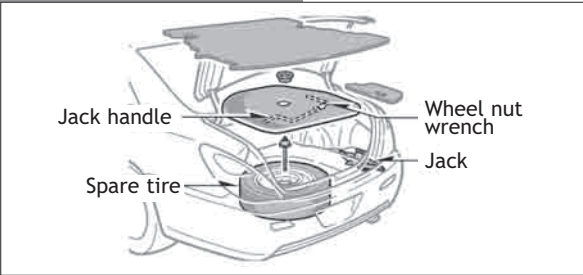

### Removing the spare tire

#### Temporary tire

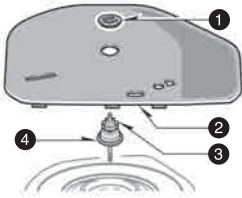

#### Full-sized tire

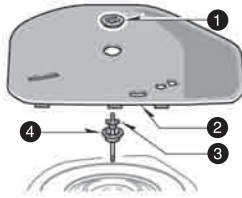

- 1 Loosen and remove the nut.
- 2 Remove the spare tire cover.
- 3 Loosen and remove the bolt.
- 4 Remove the spacer.

Refer to the *Owner's Manual* for tire changing and jack positioning procedures.

## Trunk-Internal release

